



## NEX 6 DC

<b>Drehmoment</b> <i>Torque</i>	110 Nm ... 180 Nm	<b>Leistungsaufnahme (max.)</b> <i>Power consumption (max.)</i>	5 W ... 26,5 W
<b>Stellzeit für 90°</b> <i>Actuating time for 90°</i>	40 s ... 90 s	<b>Elektrischer Anschluss</b> <i>Electrical connection</i>	0,25 mm <sup>2</sup> ... 1,5 mm <sup>2</sup> AWG 23 ... AWG 16
<b>Schutzart</b> <i>Degree of protection</i>	IP66/67	<b>Umgebungstemperatur</b> <i>Ambient temperature</i>	-20 °C ... +60 °C 0 °C ... +60 °C (ESR-... / Transmitter)
<b>Stellbereich</b> <i>Swivel range</i>	0° ... 100°  Optional: bis 100 Umdrehungen <i>optional: up to 100 turns</i>	<b>Abtriebswelle</b> <i>Output shaft</i>	Durchmesser Welle: Ø25 mm, Querbohrung: Ø10 mm, <i>diameter shaft: Ø25 mm, cross hole: Ø10 mm,</i>
<b>Kabeleinführungen</b> <i>Cable entries</i>	3 x Kabelschwanz 1 m (andere Längen optional), 3 x min. 3,5 m Hochtemperaturleitung <i>3x unconnected cable end 1 m (optional lengths available), 3 x at least 3,5 m high-temperature cable</i>	<b>Material Getriebe</b> <i>Gear material</i>	Metall <i>metal</i>
<b>Anschlussspannung/ Frequenz</b> <i>Supply voltage/frequency</i>	24V DC ± 10 %	<b>Material Gehäuse/Haube</b> <i>Material housing/hood</i>	GD-ZnAl 4 Cu 1/ Al-Si10Cu2Fe
<b>Anschluss an Armatur</b> <i>Connection to valve</i>	F07 nach DIN EN ISO 5211, Ø90 mm <i>F07 according to DIN EN ISO 5211, Ø90 mm</i>	<b>Beschichtung Gehäuse/Haube</b> <i>Coating housing/hood</i>	Korrosionsschutzklasse C2 nach DIN EN 12944-2 RAL 7037, RAL 7035 <i>corrosion protection class C2 according to DIN EN 12944-2 RAL 7037, RAL 7035</i>
<b>Einschaltdauer</b> <i>Duty cycle</i>	100 %	<b>Abschaltung</b> <i>Shut-off</i>	2 Endlagenschalter / Nocken <i>2 limit switches / cams</i>
<b>Kennzeichnung Ex</b> <i>Marking Ex</i>	II 2G Ex db IIC T6 Gb		
<b>Optionen</b> <i>options</i>	<ul style="list-style-type: none"> <li>- Potenziometer <i>potentiometer</i></li> <li>- Halleffekt Absolutwertgeber <i>hall-effect absolute encoder</i></li> <li>- Transmitter 4 ... 20 mA <i>transmitter 4 ... 20 mA</i></li> <li>- Elektr. Stellungsregler (ESR-...) <i>electr. Position controller (ESR-...)</i></li> <li>- Relais <i>relays</i></li> <li>- Antikondensationsheizung <i>anti-condensate heater</i></li> <li>- Bluetooth-Modul (App) <i>bluetooth-module (app)</i></li> </ul> <p style="text-align: center;">Weitere Ausführungen/Optionen möglich <i>Further versions/options possible</i></p>		

# Technische Spezifikation / Datenblatt

Technical Specification / Data Sheet

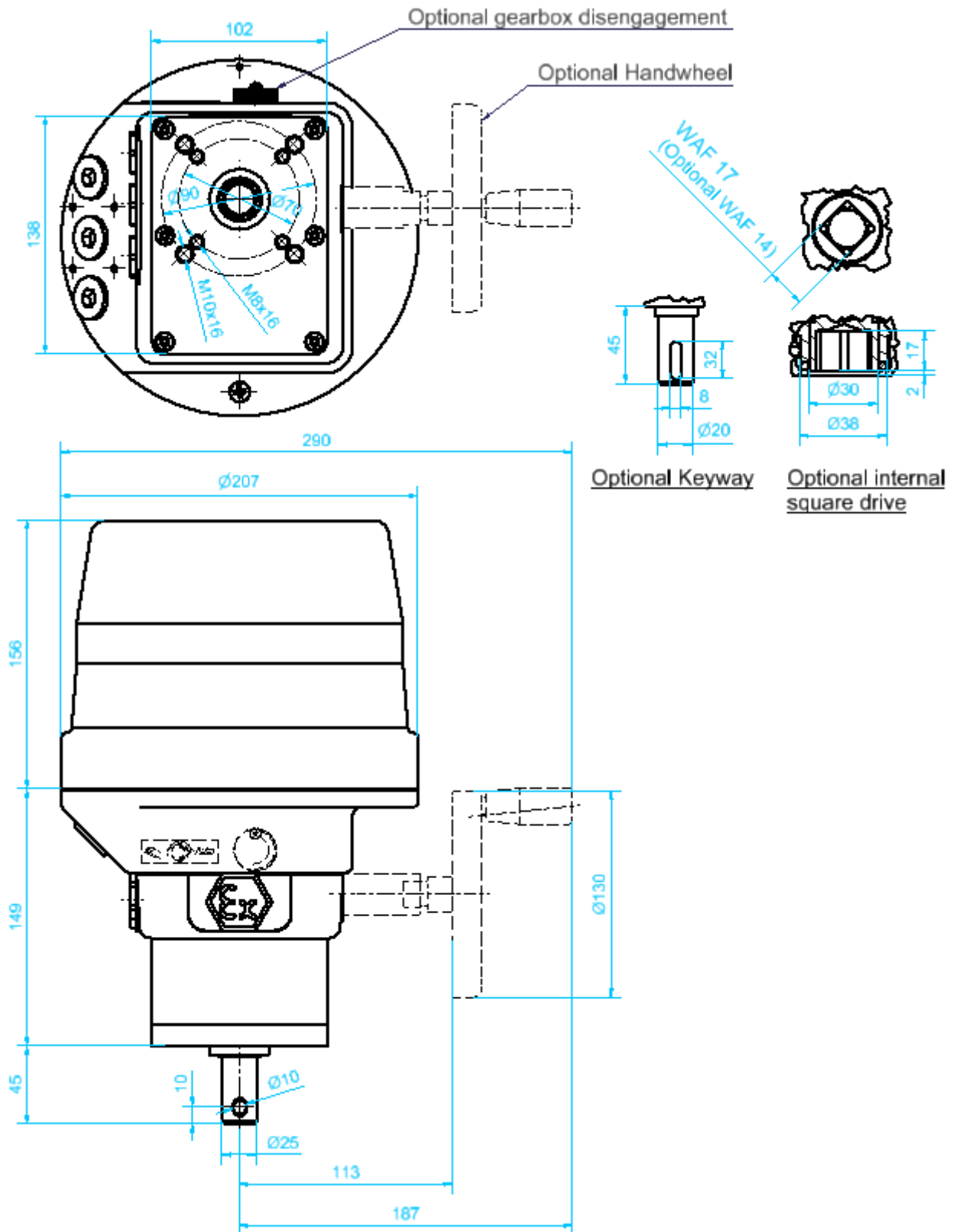

Ausgabedatum: 01.01.2024

Date of issue: 2024-01-01